

Luster Beam IIIa Tunable

PHOTOMETRIC	APPLICATION	SPECIFICATION	DIMMABLE
	General Cove Lighting	Drive Mode DC 24V (CV) Beam Angle 115° Waterproof IP44 Dimmable External Driver Indoor Outdoor Custom Order	DIM PWM TRIAC DALI DMX SPI



Input Voltage
DC24V

General / Others Specification

Items	Specification
Driven Method	DC24V (Constant Voltage)
Beam Angle	115°
CRI	> Ra90
LED Colour Bin	3 Steps MacAdam
Environment	Indoor (IP44)
Expected LED Life Span	L ₇₀ = 40,000hrs @ 25°C
Operation Temp. / Hum.	-20°C ~ 50°C / 20% ~ 85% RH
Storage Temp.	-20°C ~ 70°C

Order / Model Code

PRODUCT NAME	LENGTH	FLUX LEVEL	COLOUR (TUNABLE)	CRI	LED VERSION
Luster Beam IIIa	03 : 1 ft 06 : 2 ft 09 : 3 ft 10 : 1 m 12 : 4 ft	L : Low H : High	2250 : 2000K to 5000K	E : >90	X

Basic Specifications (Unit:mm)

White Cable : (+) DC24V
Black Cable : 5000K
Red Cable : 2200K

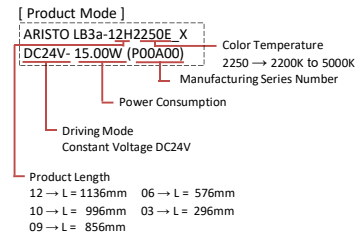
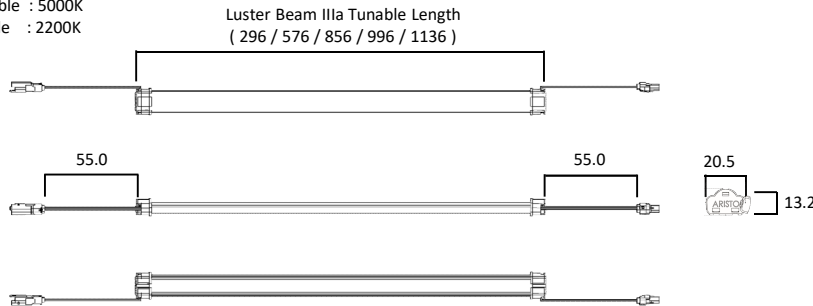

Specification (@25°C)

Flux Level	Models	CCT	Lumen (Full Load) (lm)	Rated Power (W)	Beam Angle (°)	Size (L x H x W) (mm)	Ave. Weight (g)
High Flux (13.13 W/m)	LB3a-03H2250E_X	2200K - 5000K	370	3.75	115	296 x 13.2 x 20.5	60
	LB3a-06H2250E_X		740	7.50		576 x 13.2 x 20.5	103
	LB3a-09H2250E_X		1110	11.25		856 x 13.2 x 20.5	147
	LB3a-10H2250E_X		1295	13.13		998 x 13.2 x 20.5	169
	LB3a-12H2250E_X		1480	15.00		1136 x 13.2 x 20.5	188

** Wire gauge : AWG20 x 2 single core

Flux Level	Models	CCT	Lumen (Full Load) (lm)	Rated Power (W)	Beam Angle (°)	Size (L x H x W) (mm)	Ave. Weight (g)
Low Flux (8.97 W/m)	LB3a-03L2250E_X	2200K - 5000K	250	2.56	115	296 x 13.20 x 20.50	60
	LB3a-06L2250E_X		500	5.12		576 x 13.20 x 20.50	103
	LB3a-09L2250E_X		750	7.68		856 x 13.20 x 20.50	147
	LB3a-10L2250E_X		875	8.96		998 x 13.20 x 20.50	169
	LB3a-12L2250E_X		1000	10.24		1136 x 13.20 x 20.50	188

** Wire gauge : AWG20 x 2 single core

Luster Beam IIIa Tunable

Design Item

Plastic Swivel

View : Top

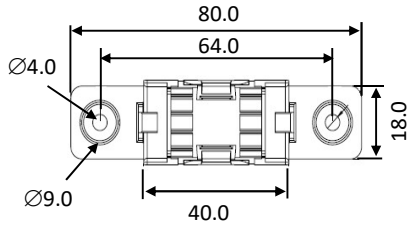

View : Bottom

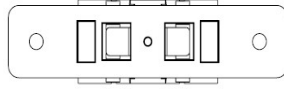

View : Side

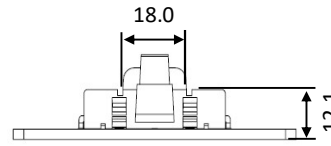

View : Side

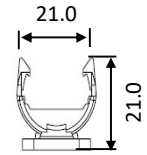

Stainless Steel Bracket

Metal Swivel



Swivel dimension
(L x H x W)
15.0 x 16.5 x 7.0

Low Profile Clip

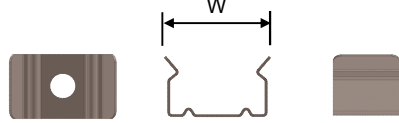

Clip dimension
(L x H x W)
12.0 x 11.3 x 17.9

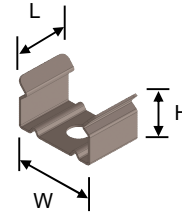

Tunable Profile

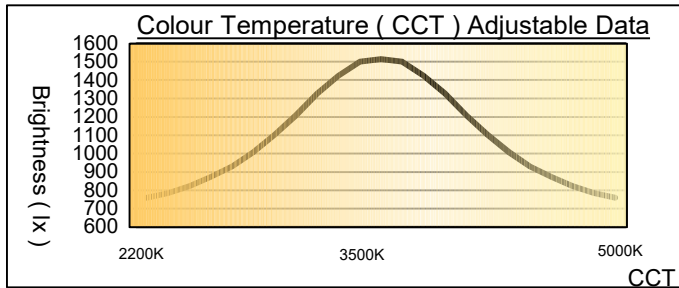

**** CCT tuning and light intensity is dependent concept
(Maintain CCT when light intensity is in adjusting mode)**

Wiring Method

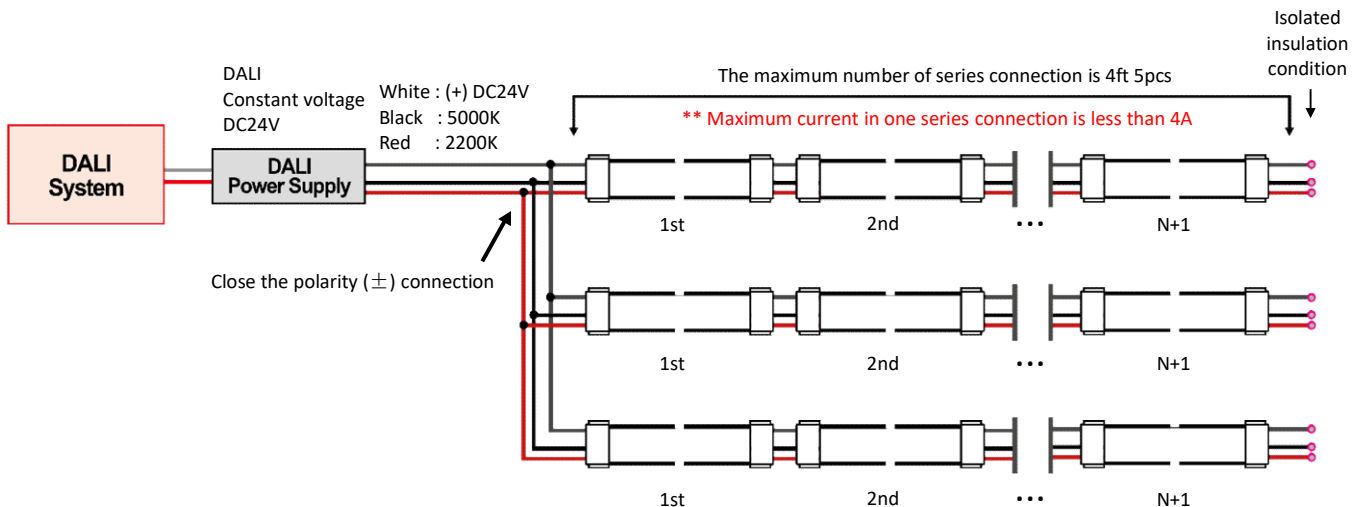

Maximum number of LED connection dimmer 2ch Total MAX. 4A

**** Please prepare to use more than 4A power supply.**